



1. Features

This product is a waterproof LED controller suitable for outdoor use. It has brightness, color temperature, RGB, RGBW and RGB+CCT output modes. Built-in WiFi module and 2.4GHz RF communication module. Support Smartphone APP (MiBoxer) and RF Remote controlling.

- WiFi wireless control
- Support amazon alexa and google assistant control
- Smartphone APP control
- Compatible with 2.4GHz RF remote controller
- Signal transmitting & modes synchronization
- DMX512 controllable (DMX512 LED transmitter is needed)
- 16 Millions of colors to choose
- Color temperature 2700K-6500K
- Dim brightness/ Saturation
- Timing ON/OFF the lights by APP
- Group control randomly by APP
- Waterproof and dustproof grade IP67

2. Parameters

Model No.: WL5-WP
 Input Voltage: DC12V~36V
 Output: 6A/Channel
 Total Output Max: 20A
 Communication Mode: WiFi-IEEE 802.11b/g/n 2.4GHz
 RF: 2.4GHz
 Remote control distance: 30m
 Working Temperature: -20~45°C

Waterproof 5 in 1 WiFi LED Controller
 Model No.: WL5-WP

4. Connect diagram

Controller input voltage must be in accordance with the required voltage of LED Strips.

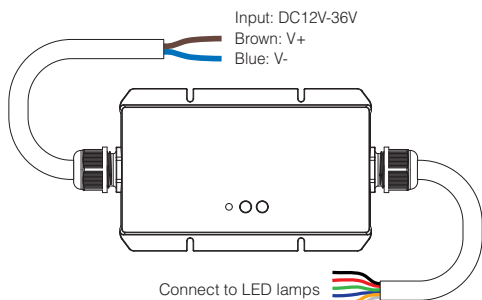

Note: the connection method is different for different output mode. Please connect it according to below sheet.

Output Mode (LED Wiring)							
Mode	Wire	Black	Red	Green	Blue	White	Yellow
Single Color		V+	W	W	W	W	W
Dual White		V+	CW	CW	WW	WW	
RGB		V+	R	G	B		
RGBW		V+	R	G	B	W	
RGB+CCT		V+	R	G	B	CW	WW

Single Color

Output mode connection diagram

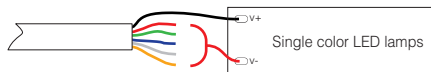

Dual White

Output mode connection diagram



RGB

Output mode connection diagram

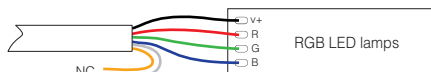

RGBW

Output mode connection diagram

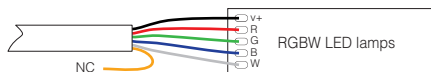

RGB+CCT

Output mode connection diagram

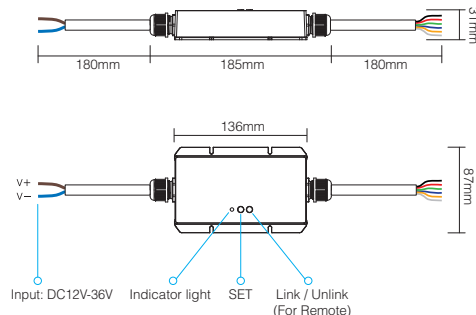
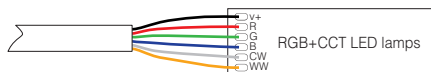

3. Function Instruction

3.1. Switching Output Mode

Short press " SET " button to switch the output mode; The indicating light flickering means switching successfully; Different colors flickering correspond to different output mode, details see below sheet.

Indicating Light Color	Output Mode
White Light Blinking Quickly	Single Color Mode
Yellow Light Blinking Quickly	Dual White Mode
Red Light Blinking Quickly	RGB Mode
Green Light Blinking Quickly	RGBW Mode
Blue Light Blinking Quickly	RGB+CCT Mode

5. RF Remote Link / Unlink

- Link:**
- Short press the " Link/Unlink " button once on the LED controller(or switch off the controller power. After 10 seconds, switch on again). The indicator light flashes red and green alternately.
 - Short press Link/Unlink button on the remote (i.e. " | " or " [X] ") 3 times within 3 seconds. The green light flashing 3 times slowly means linking successfully.

Unlink: Long press " Link/Unlink " button on the LED controller for 3 seconds. The red light flashing 10 times quickly means unlink successfully. (Or follow the unlinking steps on the remote instruction.)

Note:

Remote controller need to be purchased separately. The remote linking and unlinking method, please see details on remote instruction.

Compatible with these remote controls (Purchased separately)

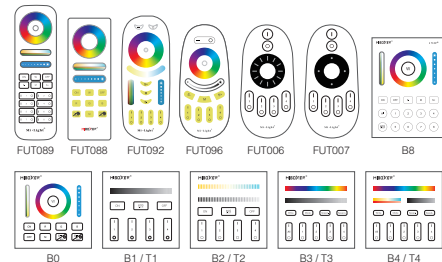

3.2. Signal transmitting

One lighting fixture can transmit the signals from the remote control to another lighting fixture within 30m, as long as there is a lighting fixture within 30m, the remote control distance can be limitless.

3.3. Modes synchronization

Different lighting fixture can work synchronously when they are started at different times, controlled by the same remote, under same different mode and within 30m distance.

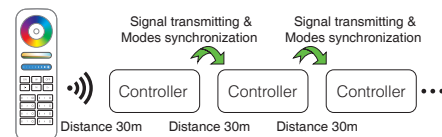

3.4. Dynamic Mode Sheet

Note: only suitable for RGB/RGBW/RGB+CCT output mode.

Number	Dynamic Mode	Brightness / Saturation / Speed
1	Mardi gras	Adjustable
2	Automatic color change	
3	Sam	
4	Gemstone	
5	Twilight	
6	American	
7	Fat tuesday	
8	Party	
9	Slow color splash	

6. MiBoxer APP Control

- Long press "SET" three seconds, device go into wifi configuration mode when red indicator blinking.
- Log in MiBoxer APP and click the " + " on the right top corner, then select "Waterproof LED controller(WL5-WP)". Follow the hints to complete the device adding.

Indicating light instruction:

Red light always-on	Red light blinking	Green light always-on	Green light blinking	Yellow light blinking
Disconnected from network	Smart Link mode	Networking successfully	Received signal	Device malfunction

7. Attention

- Please check whether the input voltage of the constant voltage power supply is in accordance with the controller, and please check the connection of both the cathode and anode.
- Non-professional user cannot dismantle the controller directly, otherwise, it may cause fire and electric shock.
- Please do not use controller around the mental area and high magnetic field, otherwise, it will badly affect the control distance.

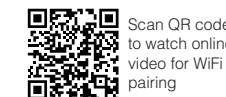

Scan QR code to watch online video for WiFi pairing

Made in China



MiBoxer APP

User Instruction

1 APP Downloading

For IOS System: Pls search "MiBoxer" on APP store. (Above IOS9.0)

For Android System: search "MiBoxer" on Google Play (Above Android 5.0) or Scan below QR-code to download APP.



Scan QR Code to Install APP

2 Register MiBoxer Account

Open APP and click Register button; Complete the register and log in.

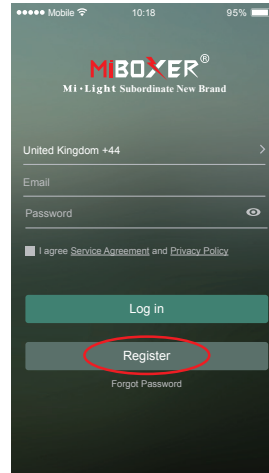

3 Add Device

1. Click the right top "+" on the device list.
2. Please select the device type you will add, then complete the adding according to the hint of APP.
3. Back to device list after adding successfully, then pull down refresh in list to get the device status.

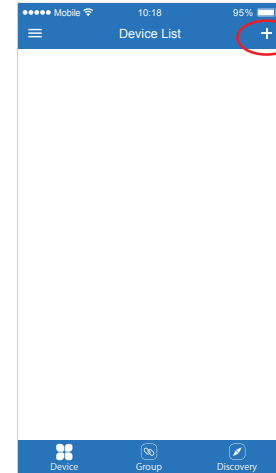

4 Modify device name or delete device

Slide device list to left, click "Edit" to modify device name; click "Delete" to delete device.

Note: If the device was shared to others, then the device will also be deleted on your friends' device list.

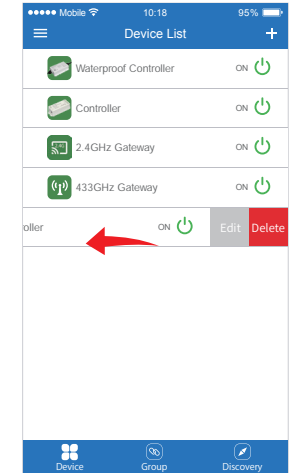

5 Group Control

1. Click to switch to Group list, then click the right top icon on the Group list to create groups.

2. Slide the Group list to left to **Edit / Delete** groups.

Note: The group just work on APP Controlling, cannot work on Voice control. Please open third party APP for Group Voice control.

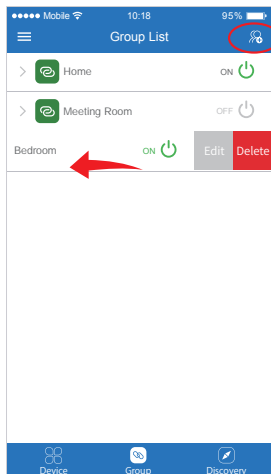

6 APP Control

Click the device or group that you want to dim on device list and group list into Dimming Interface.

Click speed+ under dynamic mode.

Click speed- under dynamic mode.

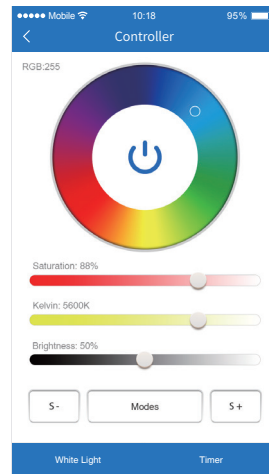

7 Third Party Voice Control instructions

Search "Mi-Light Smart" on third-party platform APP and set up.

Click left top icon on the home page;

Then click "Voice Control" to check detailed instructions.

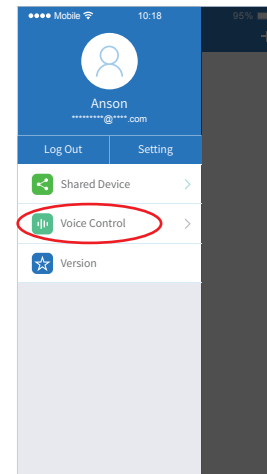

8 Sharing Device

Share the device to friends, Let your friends can control this device.

1. Click the left top icon on the home page.
2. Click "Shared Device" to My sharing, then click "Add sharing" (Note: the receiving sharing device cannot be shared again).
3. Click "Jack" to edit sharing, slide to left to delete sharing.

