

WiFi & RF Smart AC Switch

Model No.: Tuya SPT15A

Tuya APP cloud control / Voice control / Push on/off / Relay output / Zero-crossing detection

Features

- WiFi + RF + AC push smart switch, without dimming function.
- To switch single color LED lamps, traditional incandescent and halogen lights.
- Tuya APP cloud control, support on/off, delay turn on/off light and timer run function.
- Voice control, support for Amazon Alexa, Google Assistant, Tmall Genie and Xiaodu smart speakers.
- Compatibility with RF 2.4G dimming remote control.
- Each controller can also work as WiFi-RF converter, then use Tuya APP to control one or more RF switch or controller synchronously.
- Connect with external push switch optional.
- High-inrush specification relays (normally open).



CE RoHS  RED

Technical Parameters

Input and Output		Safety and EMC		Environment	
Input voltage	AC100-240V	EMC standard(EMC)	ETSI EN 301 489-1 V2.2.3	Operation temperature	Ta: -30 °C ~ +55 °C
Output voltage	AC100-240V		ETSI EN 301 489-17 V3.2.4	Case temperature (Max.)	Tc: +85 °C
Output current	1.5A (Resistive load)	Safety standard	EN 62368-1:2020+A11:2020	IP rating	IP20
	10A (inductive load)		Radio Equipment(RED)	ETSI EN 300 328 V2.2.2	Package
Output power	1500-3600W	Certification	CE,EMC,RED	Size	L60x W60 x H40mm
Relay surge current	120A (20ms)	Warranty		Gross weight	0.061kg
Input signal	Tuya APP+ Push switch + RF 2.4GHz	Warranty	2 years		
RF Control distance	30m (Barrier-free space)				

Mechanical Structures and Installations

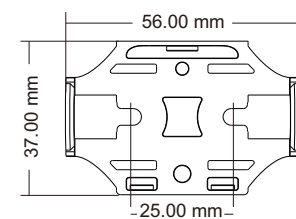
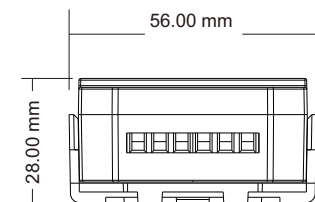
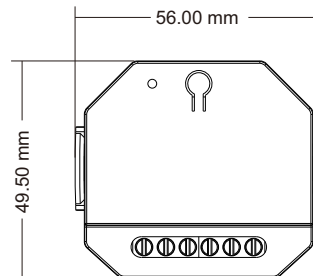
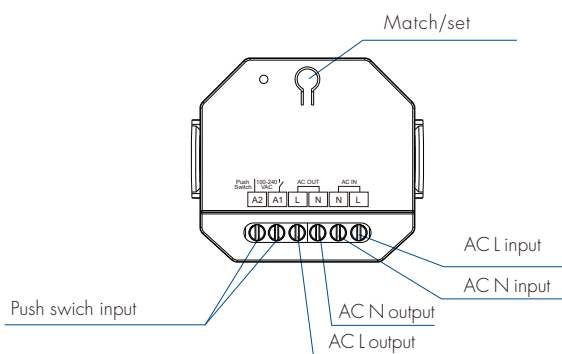

Installation method

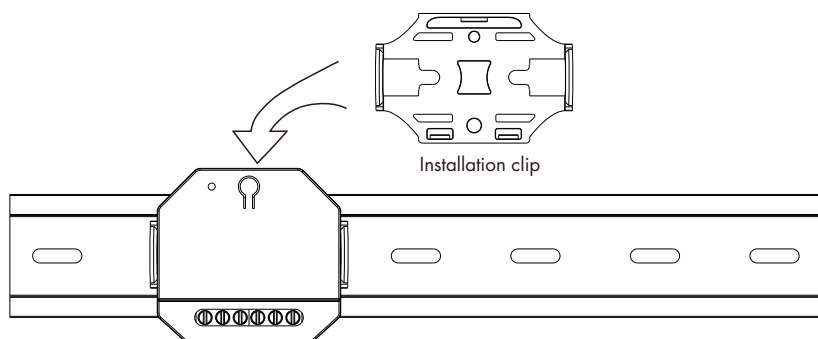

Note:

1. The installation must be installed or removed by a professional electrician.
2. Please keep the device out of the reach of children.
3. Please keep away from water, humid or hot environment.
4. The device should be kept away from strong signal sources (such as microwave ovens) to avoid signal interruption and cause the device not to work properly.
5. Avoid placing the device close to or near high-density materials (such as metal, concrete walls, etc.), which will reduce or block the wireless signal.

Wiring diagram

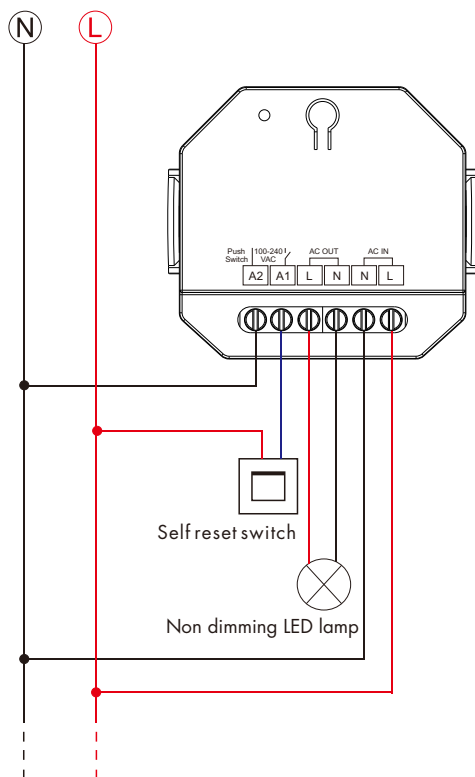

Self reset switch:
Short press, turn on the light;
Short press again, turn off the light.

Note:
The MAX. surge current of the switch is 120A.
When connecting multiple capacitive (LED power supplies) or inductive loads,
the sum of the surge currents can not exceed its maximum value.
Otherwise, long-term use may cause product damage.

System wiring

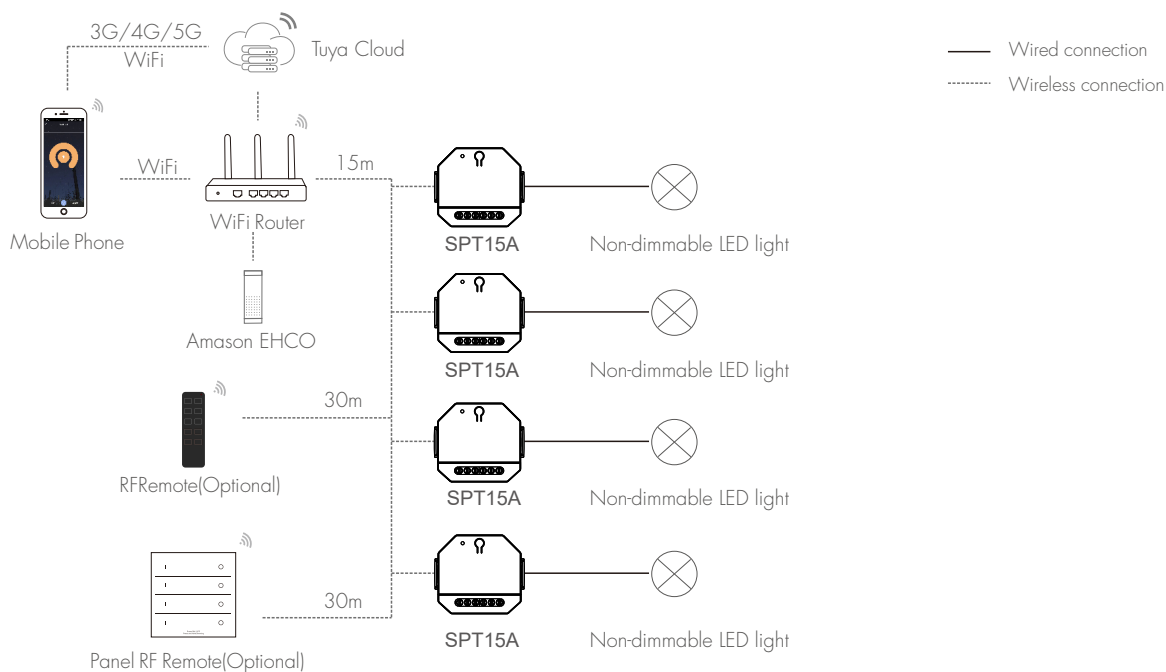

Note:

1. The above distance is measured in spacious (no obstacle) environment, Please refer to the actual test distance before installation.
2. Please check if the WiFi router net in 2.4G band, the 5G band is not available, and do not hide your router network.
3. Please keep the distance between devices and router close, and check the WiFi signals.
4. WiFi signal strength detection: open the main interface of socials, click enter the device interface, click "check device network" for testing.

APP operating instruction

Please download the corresponding Tuya/Smart life App according to your region.

Press and hold Match/Set key for 2s, or push twice Match/Set key fastly, clear previous network connection, enter Smart config mode, the blue LED indicator flash fastly.

Press and hold Match/Set key for 5s, clear previous network connection, enter AP config mode, the blue LED indicator flash slowly. If smart config failed, please try AP config.

Repeat power on and off for 5 consecutive times, also clear previous network connection, enter Smart config mode, the output LED will flash 10 times.

If Tuya APP network connection succeed, the blue LED indicator will stop flash, and in Tuya APP, you can find SWITCH device.



Smart life APP



Tuya Smart

APP interface

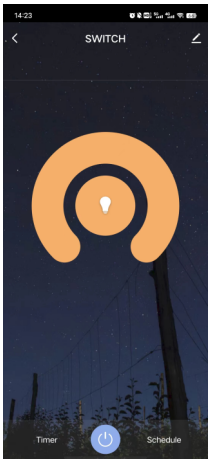

Switch Interface

Touch on/off key to turn on or off light.

The Timer can be set to automatically turn on or off lights for the next 24 hours

The schedule can be add multiple timers to turn on or off the lights according to different times.

SPT15A match RF remote control

User can choose the suitable match/delete ways. Two options are offered for selection:

Use the SPT15A's Match key

Match:

Short press match key,
immediately press on/off key (single zone remote)
or zone key (multiple zone remote) on the remote.

Delete:

Press and hold match key for 10s to delete all match, The light
blinks 5 times means all matched remotes were deleted.

Use Power Restart

Match:

Power on, power off, and then repeat again,
Immediately short press on/off key (single zone remote)
or zone key (multiple zone remote) 3 times on the remote.
The light blinks 3 times means match is successful.

Delete:

Power on, power off, and then repeat again,
Immediately short press on/off key (single zone remote)
or zone key (multiple zone remote) 5 times on the remote.
The light blinks 5 times means all matched remotes were deleted.

SPT15A work as WiFi-RF converter to match other RF switch or controller

User can choose the suitable match/delete ways. Two options are offered for selection:

Use the controller's Match key

Match:

Short press match key of the controller,
immediately press on/off key on the Tuya APP.
The LED indicator fast flash a few times
means match is successful.

Delete:

Press and hold match key of the controller for 5s,
The LED indicator fast flash a few times
means match was deleted.

Use Power Restart

Match:

Switch off the power of the controller, then switch on power, repeat again,
Immediately short press on/off key 3 times on the Tuya APP.
The light blinks 3 times means match is successful.

Delete:

Switch off the power of the controller, then switch on power, repeat again,
Immediately short press on/off key 5 times on the Tuya APP.
The light blinks 5 times means match was deleted.