

TUBO

LED SURFACE MOUNTED LUMINAIRE

LED SVÍTIDLO PŘISAZENÉ



- EN** Technical specification
CZ Technické specifikace

Watts / Příkon	8W
Volts / Vstupní napětí	220-240V
Ingress protection / IP krytí	IP44
Beam angle / Úhel svitu	60°
Colour temperature / Barevná teplota	CCT (3000K+4000K+6500K)
Luminous flux / Světelný tok (lm)	650lm / 700lm / 720lm



- EN** Dimensions
CZ Rozměry

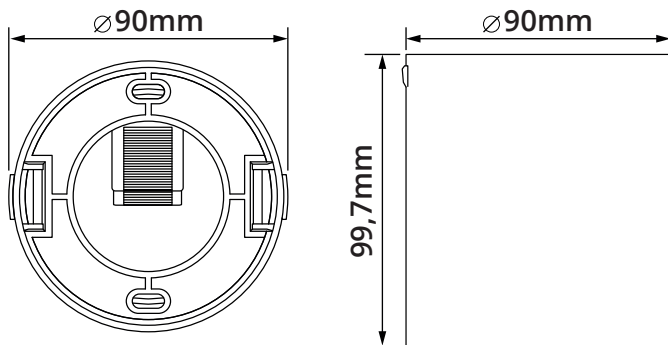

- EN** What is in the box
CZ Obsah balení

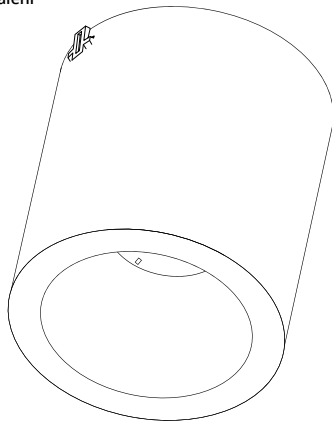

Installation guide / Montážní návod

- EN**
1. All handling with the luminaire must be carried out only when the luminaire is disconnected from the mains.
 2. Screw the bracket on the ceiling.
 3. Connect the cable.
 4. Insert the luminaire to the bracket.
 5. Turn on the switch of the mains.
- CZ**
1. Veškerou manipulaci se svítidlem provádět pouze při odpojeném napájení ze sítě.
 2. Pomocí šroubů připevněte držák na strop.
 3. Připojte přívodní kabely ke svítidlu.
 4. Připevněte svítidlo k držáku.
 5. Zapněte přívod napájení.

1

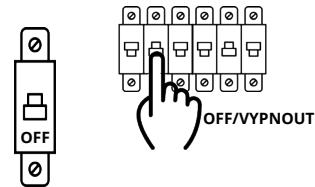

2

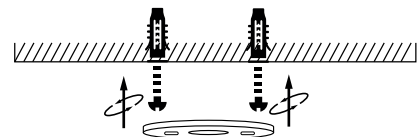

3

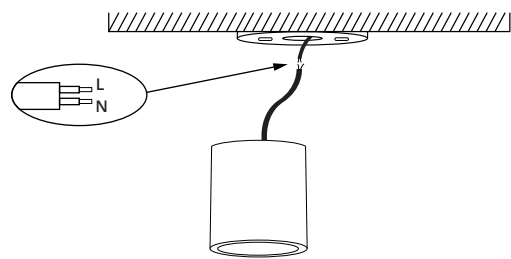

4

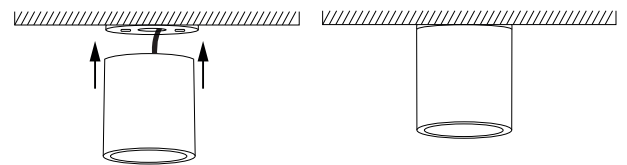

5

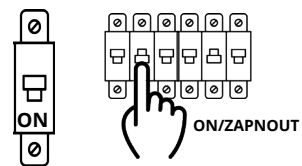

WARNING / UPOZORNĚNÍ

- EN** Installation can be carried out by a qualified person only
DE Montage darf nur qualifizierte Person durchführen
CZ Instalaci smí provádět pouze odborně způsobilá osoba
SK Montáž môže vykonávať iba kvalifikovaná osoba
HU A szerelést megfelelő szakképzettséggel rendelkező személynek kell végeznie
PL Montażu dokonywać może tylko wykwalifikowana osoba

